

i.life 150cm x 70cm Rectangular Idealform Bath

ILLUSTRATED

- T4770** i.life 150cm x 70cm rectangular idealform bath with no taphole
- T4828** i.life Fixation Set
- BD264** Ceraplan dual control bath filler
- E4796** Unilux Plus+ 150cm front panel
- E3169** Unilux 70cm end panel
- S8970** Trap 1½" plastic P with 75mm seal, multi-purpose outlet suitable for plastic and BS copper pipe
- E1486** Luxury bath pop-up waste and overflow
- A5901** TMV thermostatic mixing valve, 22mm

ILLUSTRATED PRODUCT DETAILS









Weights

- T4770** 17.50 KG
- BD264** 2.39 KG
- E4796** 3.30 KG
- E3169** 2.58 KG
- S8970** 1.00 KG
- A5901** 0.60 KG

Materials

- T4770** Acrylic
- T4828** Acrylic
- BD264** Chrome Plated Brass
- E4796** High Impact Polystyrene
- E3169** High Impact Polystyrene
- S8970** Plastic
- E1486** Mixed Material
- A5901** Chrome Plated Metal

Finishes

- T4770**  White (01)
- T4828**  White (01)
- BD264**  Chrome (AA)
- E4796**  White (01)
- E3169**  White (01)
- S8970**  Neutral / No Finish (67)
- E1486**  Chrome (AA)
- A5901**  Chrome (AA)

Capacity

- T4770** 150.0 litres (to overflow)

Designer

Palomba Serafini Associati

FINISH OPTIONS



Standards

EN 198:2008. EN 14516

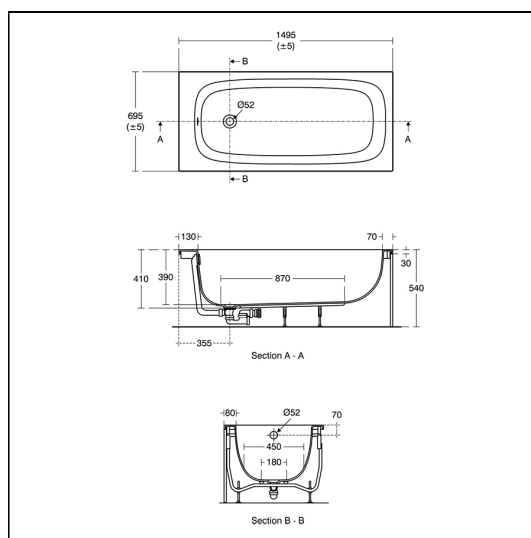

FEATURES

