

Tempo Arc Idealform Plus+ Shower Bath 170x80cm LH No Handgrips No Tapholes

ILLUSTRATED

- E2576** Tempo Arc 170 x 70/80cm Idealform Plus+ shower bath. left hand, no handgrips no tapholes
- B0730** Tempo 2 hole bath filler
- E2569** Tempo Arc shower bath front panel
- E3169** Unilux 70cm end panel
- E1486** Luxury bath pop-up waste and overflow
- E2571** Tempo Arc shower bath screen, Clear Glass and Bright Silver finish
- A5901** TMV thermostatic mixing valve 22mm

ILLUSTRATED PRODUCT DETAILS







Weights

- E2576** 42.00 KG
- B0730** 2.64 KG
- E2569** 5.00 KG
- E3169** 2.58 KG
- E2571** 27.00 KG
- A5901** 1.70 KG

Materials

- E2576** Idealform Plus+
- B0730** Chrome Plated
- E2569** Acrylic
- E3169** Acrylic
- E1486** Mixed Material
- E2571** Toughened Safety Glass
- A5901** Chrome Plated Metal

Finishes

- E2576**  White (01)
- B0730**  Chrome (AA)
- E2569**  White (01)
- E3169**  White (01)
- E1486**  Chrome (AA)
- E2571**  Bright Silver (EO)
- A5901**  Chrome (AA)

Capacity

- E2576** 195.0 litres (to overflow)

Flow rates

- B0730** 50 Litres per minute @ 3 bar pressure

Designer

Robin Levien, RDI

Standards

Constructed to EN 198:2008. EN 14516

Special Notes

Consideration should be given to safe hot water delivery and the use of an appropriate temperature reduction device see A5901AA or Part G for guidance.

To be used with E2571EO Tempo Arc shower bath screen

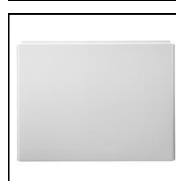
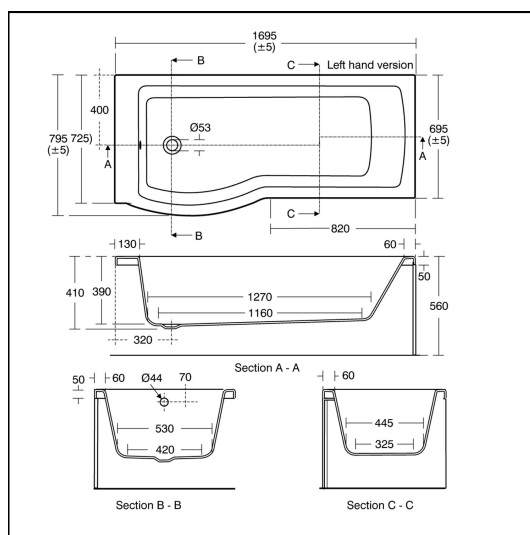

ACCREDITATIONS

B0730(AA)

Unified Water Label  50.00 Litres Per Minute

E2576(01)

Unified Water Label  195.0 Litres