

# Oleas M3 mechanical dual flushplate

## ILLUSTRATED

**R0123** Oleas M3 mechanical dual flushplate Ideal Standard - chrome

## OPTIONS

- R0140** ProSys 820mm height, mechanical wall hung WC frame, 150 depth, front or top actuation
- R0153** ProSys 1150mm height, mechanical wall hung WC frame, 120 depth, front actuation
- R0101** ProSys freestanding half frame for wall hung WC pans (no cistern)
- R0142** ProSys 150 depth wc cistern, mechanical front or top actuation
- R0317** ProSys 120 depth WC cistern, mechanical, front actuation

## ILLUSTRATED PRODUCT DETAILS

### Weights

**R0123** 0.34 KG

### Finishes

**R0123**  White (AC)

### Materials

**R0123** Mixed Material

### Designer

Robin Levien, RDI

## FINISH OPTIONS



(AC) White



(AA) Chrome



(JG) Brushed Chrome



(A6) Black

### Special Notes

For use with ProSys mechanical actuation WC frames and cisterns.

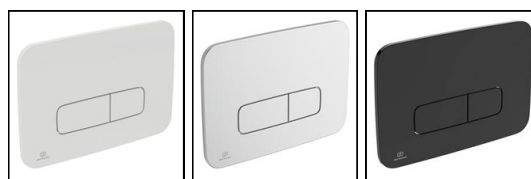
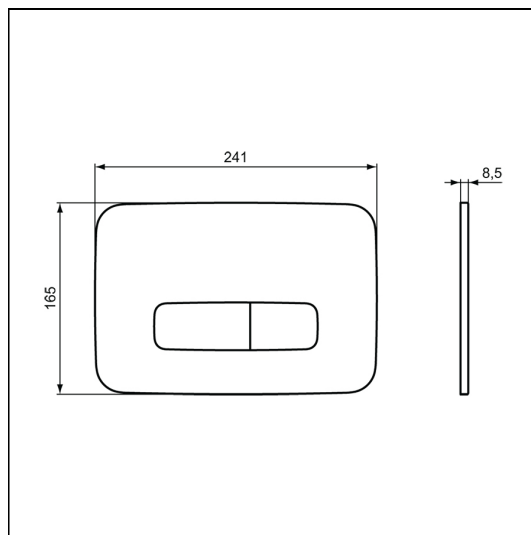

## FEATURES

