

Concept 170cm x 70cm Idealform Bath No Tapholes

ILLUSTRATED

- E7352** Concept 170 x 70cm Idealform bath with no tapholes
- B9929** Concept bath filler 2 hole dual control
- E3194** Unilux 170cm front panel
- E3169** Unilux 70cm end panel
- S8970** Trap 1½" plastic P with 75mm seal, multi-purpose outlet suitable for plastic and BS copper pipe
- E1486** 1 1/2" Bath pop-up waste and overflow
- A5901** TMV Thermostatic mixing valve 22mm

OPTIONS

- B0730** Tempo 2 hole bath filler

ILLUSTRATED PRODUCT DETAILS







Weights

- E7352** 20.70 KG
- B9929** 2.64 KG
- E3194** 3.65 KG
- E3169** 2.58 KG
- S8970** 1.00 KG
- A5901** 1.70 KG

Materials

- E7352** Idealform
- B9929** Chrome Plated Brass
- E3194** Acrylic
- E3169** Acrylic
- S8970** Plastic
- E1486** Mixed Material
- A5901** Chrome Plated Metal

Finishes

- E7352**  White (01)
- B9929**  Chrome (AA)
- E3194**  White (01)
- E3169**  White (01)
- S8970**  Neutral / No Finish (67)
- E1486**  Chrome (AA)
- A5901**  Chrome (AA)

Capacity

- E7352** 174 litres (to overflow)

Flow rates

- B9929** 80 Litres per minute @ 3 bar pressure

Designer

Robin Levien, RDI

Standards

Constructed to EN 198:2008

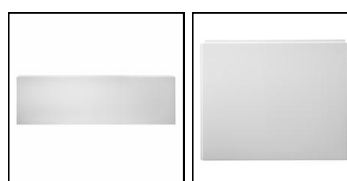
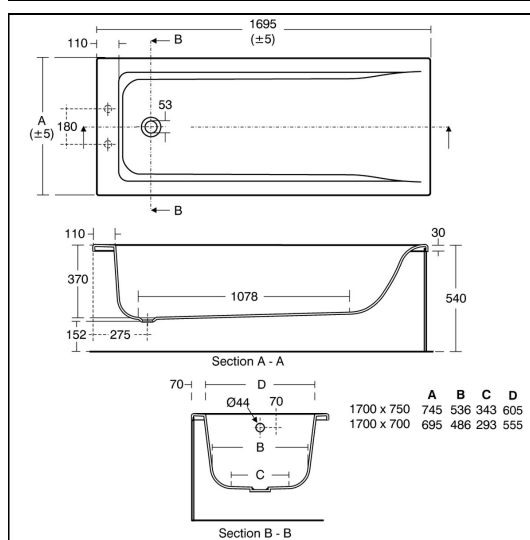

ACCREDITATIONS

E7352(01)



B0730(AA)



B9929(AA)



Concept 170cm x 70cm Idealform Bath No Tapholes



FEATURES

