

Nisa Steel Bath 170cm 2 Taphole Handgrips

ILLUSTRATED

- S1863** Nisa 170 x 70cm Steel bath, chrome plated grips, anti slip*, 2 tapholes
- B9870** Sandringham 21 bath filler 2 hole
- S0915** Bath flat front panel
- S0916** Bath flat end panel
- S9365** Bath panel plastic corner edge strip
- S8970** Trap 1½" plastic P with 75mm seal, multi-purpose outlet suitable for plastic and BS copper pipe
- S8830** Waste 1½" bath chain and overflow, plastic plug

ILLUSTRATED PRODUCT DETAILS







Weights

- S1863** 50.35 KG
- B9870** 2.10 KG
- S0915** 2.14 KG
- S0916** 3.50 KG
- S9365** 0.01 KG
- S8970** 1.00 KG
- S8830** 1.78 KG

Materials

- S1863** Porcelain Enamelled Steel
- B9870** Chrome Plated Brass
- S0915** Acrylic
- S0916** Acrylic
- S9365** Plastic
- S8970** Plastic
- S8830** Mixed Material

Finishes

- S1863**  White (01)
- B9870**  Chrome (AA)
- S0915**  White (01)
- S0916**  White (01)
- S9365**  White (01)
- S8970**  Neutral / No Finish (67)
- S8830**  Chrome (AA)

Capacity

- S1863** 169 litres (to overflow)

Flow rates

- B9870** 16.5 Litres per minute @ 3 bar pressure

Standards

BS 1390: 1990. EN 14516

Special Notes

*Anti slip is a resistant finish that reduces the chances of slipping, it does not prevent all slipping. Not suitable in areas involving the use of special chemicals. Framework is required at installation to support rim and secure panel. Panels require trimming to size at installation.

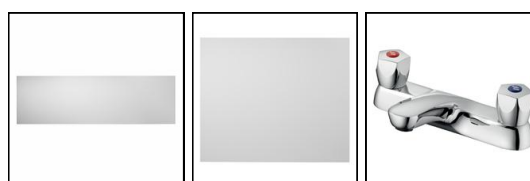
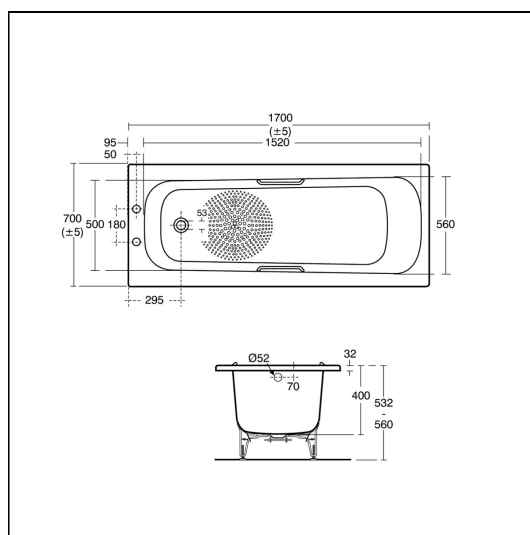

ACCREDITATIONS

S1863(01)



B9870(AA)



FEATURES

